

Multifunction Timers

CT-MVS Series

Function Diagrams

CT-MVS Function Diagrams

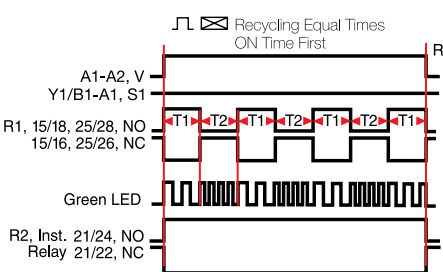
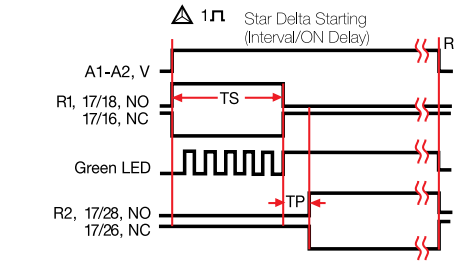
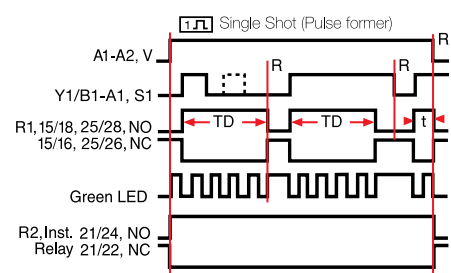
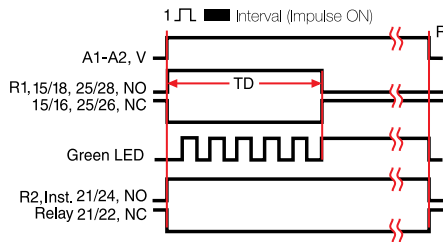
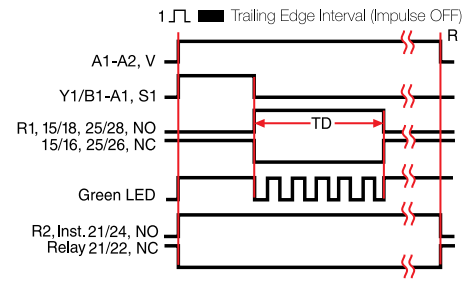
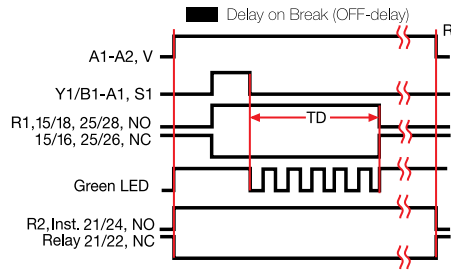
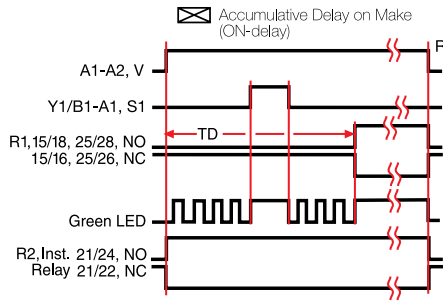
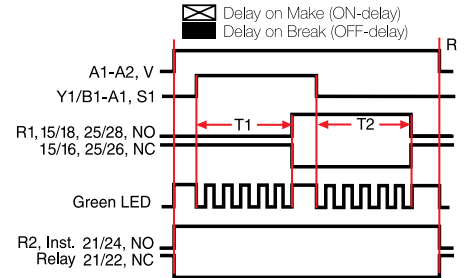
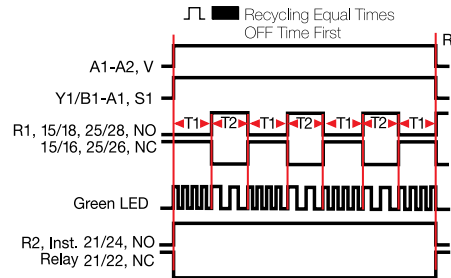
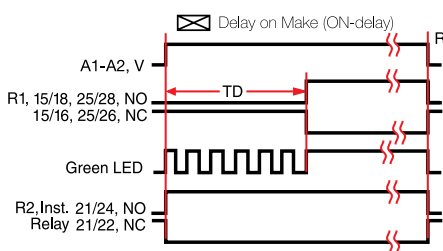

Legend

- V = Voltage
- NO = Normally Open
- TD = Time Delay
- NC = Normally Closed
- R = Reset
- S1 = Initiate Switch
- T1 = First Delay
- T2 = Second Delay = T1
- TP = 50ms Pause Delay
- t = Incomplete Time Delay
- R1 = Wye Start Relay
- R2 = Delta Run Relay
- \square = Undefined Time

MV/SFpp 01.18.08